

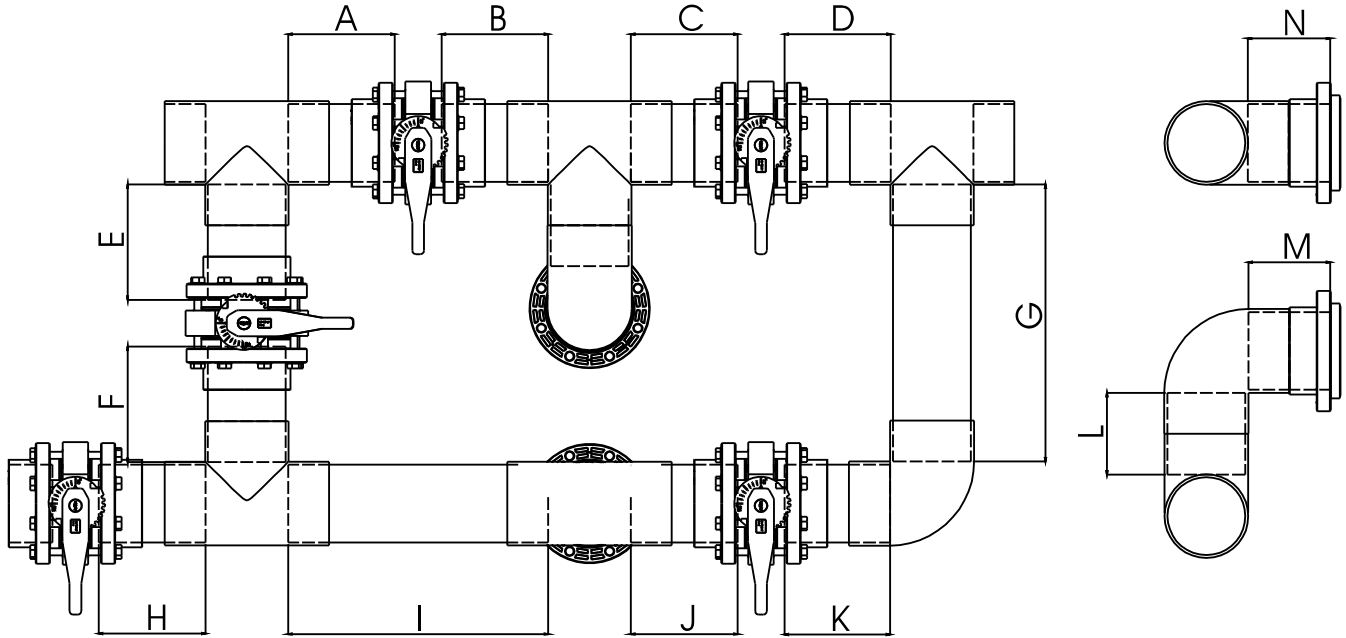

BUTTERFLY VALVE FOR COMMERCIAL FILTERS

CODE: AV275 / AV290 / AV211 / AV212



5 WAY BUTTERFLY VALVE

Code	A mm	B mm	C mm	D mm	E mm	F mm	G mm	H mm	I mm	J mm	K mm	L mm	M mm	N mm
AV275	200	150	150	150	197	197	452	150	410	150	150	102	114	114
AV290	170	170	170	170	215	215	480	170	395	170	160	130	130	130
AV211	210	210	210	210	253	253	595	210	510	210	210	180	180	180
AV212	300	300	300	300	325	325	780	300	730	300	300	230	230	230

WORKING PROCESS

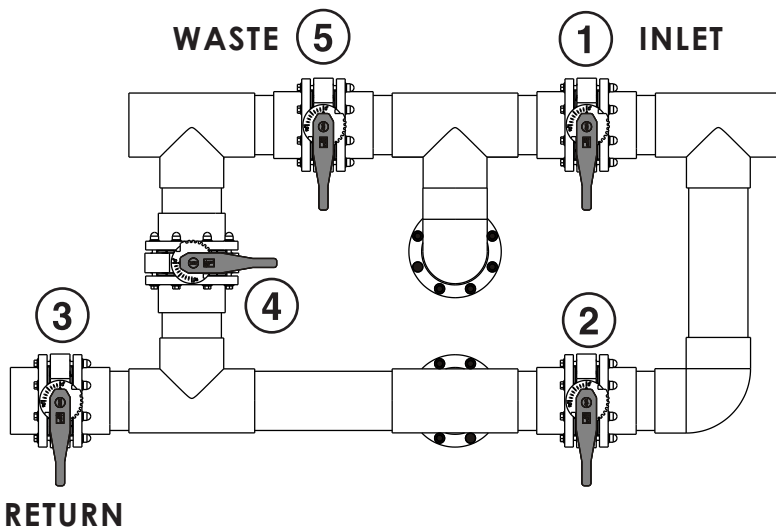

	①	②	③	④	⑤
FILTER	open	close	open	close	close
BACKWASH	close	open	close	close	open
RINSE	open	close	close	open	close
WASTE	open	close	close	close	open
RECIRCULATE	close	open	open	close	close

5 WAY BUTTERFLY VALVE INSTALLATION

Tools required for installation: ① Level gauge ② PVC Pipe glue ③ Two wrenches ④ Sand paper
Installation must be completed before putting sand into the filter .

STEP 1 – PREPARE FOR THE BUTTERFLY VALVE ASSEMBLY

1. Align the two unions, two flange panels and a butterfly valve as shown in Figure 1. Use the bolts and nuts provided to fasten these parts together (Figure 2). Ensure that each butterfly valve should be fastened by eight bolt and nuts (Figure 3).

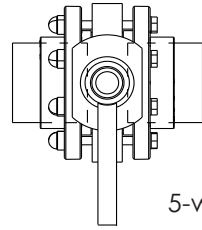
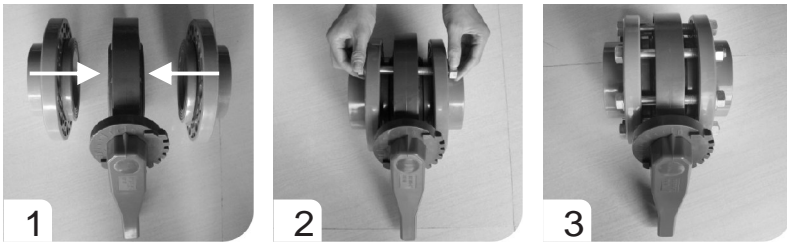

5-way butterfly valve needs 5 valves

STEP 2 - INSTALLATION

HOW TO CONNECT THE PIPE

Use sand paper to slightly roughen the PVC pipe where a connection will be made, then apply PVC glue on the contact area before connecting the pipe together.

1) Install two flange panels and unions to the connector of the sand filter by using a wrench (Figure 4). Again, please ensure that each flange panel and union should be fastened by eight bolt and nuts. Use pipe glue to fix the T-joint pipe to the lower pipe connector of the sand filter, make sure the pipe opening is installed vertically (Figure 5). Use pipe glue to fix the Elbow pipe to the upper pipe connector, make sure it is installed in the same level as the T-joint and the pipe opening should be horizontal (Figure 6-7).

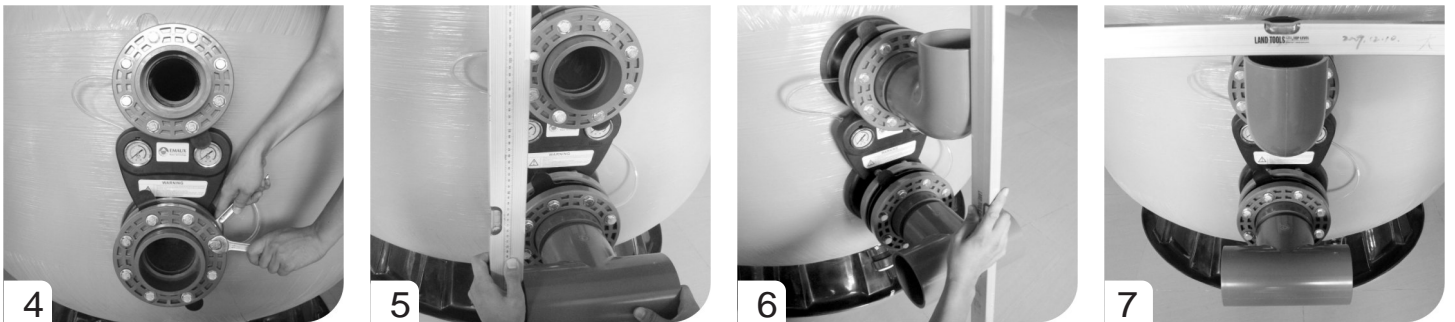

2) Use pipe glue to fix a T-joint pipe on the Elbow you just installed, make sure it is in the same level as the other T-joint pipe. (Figure 8-9). Then glue the butterfly valve assembly assembled in Step 1 to the pipes (Figure 10). Make sure the butterfly valves are aligned. Then connected this butterfly valve with the pipes provided (Figure 11)

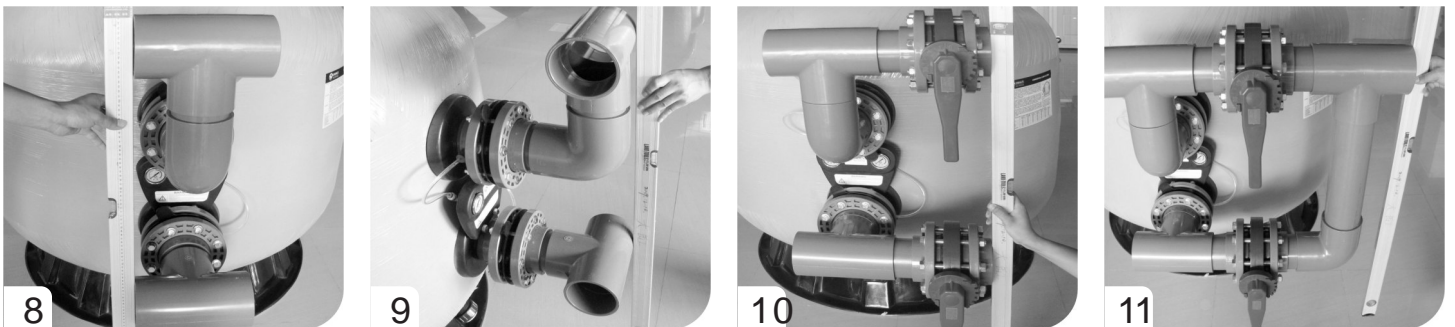

3) Glue the butterfly valve assembly to the left of the pipe connectors (Figure 12). Connect two T-joint pipes and a butterfly valve assembly together by using pipe glue, make sure the pipes at both side are aligned, as shown in Figure 13. Glue this assembly to the left side of the pipe connectors (Figure 14). Use level gauge to make sure the valve system is horizontal/ vertical (Figure 15).

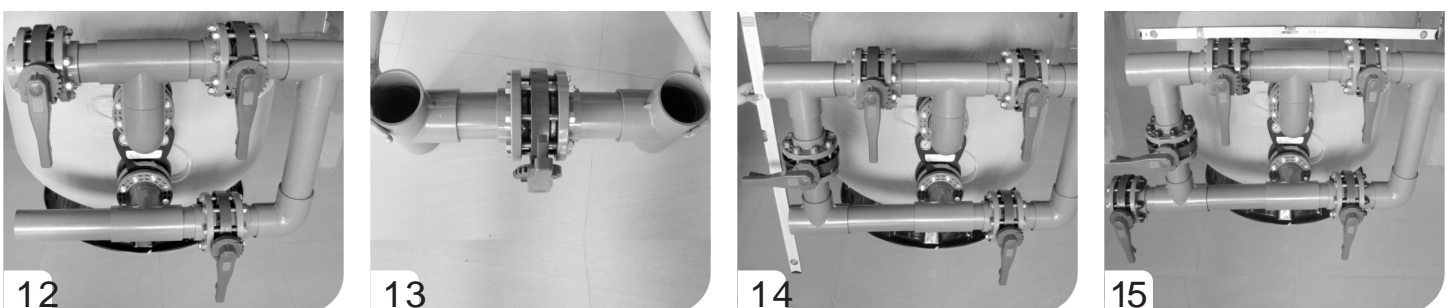

Attention: Please read the installation instructions carefully and install the valve system according the steps above .