

ATECPOOL

SIROCCO

INVERTER HEAT PUMP



Models: AIHP115 & AIHP180 & AIHP212& AIHP253

FULL DC INVERTER SWIMMING POOL HEAT PUMP

USER MANUAL

Please read this manual carefully before using and keep it in a safe place.



Contents

I. Unit Parameters	1
II. System Specification	2
1. Specification	2
2. Unit Dimensions	3
3. Exploded View	4
III. Installation Instructions	5
IV. Running Test	8
1. Inspection Before Running Test	8
2. Control Function Description	9
3. Fault Code and Solution	13
V. WIFI Settings	17

I. Unit Parameters

1. Appearance



Please read the below instructions.

- Please install the unit in compliance with local laws, regulations and standards;
- Confirm power voltage and frequency;
- The unit should be installed by a professional installer

Warning

To be installed by professional installer only

II. System Specification

1. Specification

Model	AIHP115	AIHP180	AIHP212	AIHP253
Ambient Temperature: (DB/WB) 27°C/24.3°C; Water Inlet/Outlet Temperature: 26°C/28°C.				
Heating capacity (kW)	2.8~11.5	4.35~18.0	4.72~21.2	4.78~25.3
Power input (kW)	0.193~1.73	0.306~2.78	0.33~3.59	0.33~4.36
COP	14.5~6.65	14.2~6.47	14.3~5.91	14.48~5.8
Ambient Temperature: (DB/WB) 15°C/12°C; Water Inlet Temperature: 26°C.				
Heating capacity (kW)	3.01~8.53	3.42~10.73	3.5- 14.2	3.8 - 17.1
Power input (kW)	0.393~1.592	0.453~2.167	0.47 - 2.88	0.49- 3.47
COP	7.65~5.36	7.55~4.95	7.45~4.93	7.76~4.93
Ambient Temperature: (DB/WB) 43°C/-; Water Inlet/Outlet Temperature: 30°C/28°C.				
Cooling Capacity (kW)	2.04~5.75	2.83~8.3	3.0~9.6	3.6~10.65
Consumed Power (kW)	0.48~2.90	0.69~4.53	0.75~5.36	0.88~5.98
EER	4.25~1.98	4.08~1.83	4.01~1.79	4.09~1.78
Power supply	220-240V~ / 50-60Hz		380-415V/3N~/50-60Hz	
Max.Input power(kW)	1.9	2.3	5.4	6.5
Max. current (A)	13.7	20.9	10.5	12.5
Heating temperature range	27°C~34°C			
Cooling temperature range	26°C~15°C			
Running temperature range	-10°C~48°C			
Refrigerant	R410A			
Compressor	MITSUBISHI ELECTRIC (DC inverter)			
Air side heat exchanger	Hydrophilic fin exchanger			
Water side heat exchanger	Titanium tube heat exchanger			
Water flow (m³/h)	4.7	7.7	9.1	10.9
Net dimension LxWxH (mm)	980x399x660		1125x455x765	1111x455x765
Water pipe connection	Inlet/Outlet (mm)	50		
Net weight (kg)	44	52	75	85
Noise level dB(A)	54	55	58	59

The technical specification of our heat pumps is provided for information purpose only. We reserve the right to make change without notice in advance.

1. Noise at 1m, 4m and 10m comply with Directives EN ISO 3741 and EN ISO 354.
2. Recommended size of heat pump is calculated for a covered pool.

2. Unit Dimensions

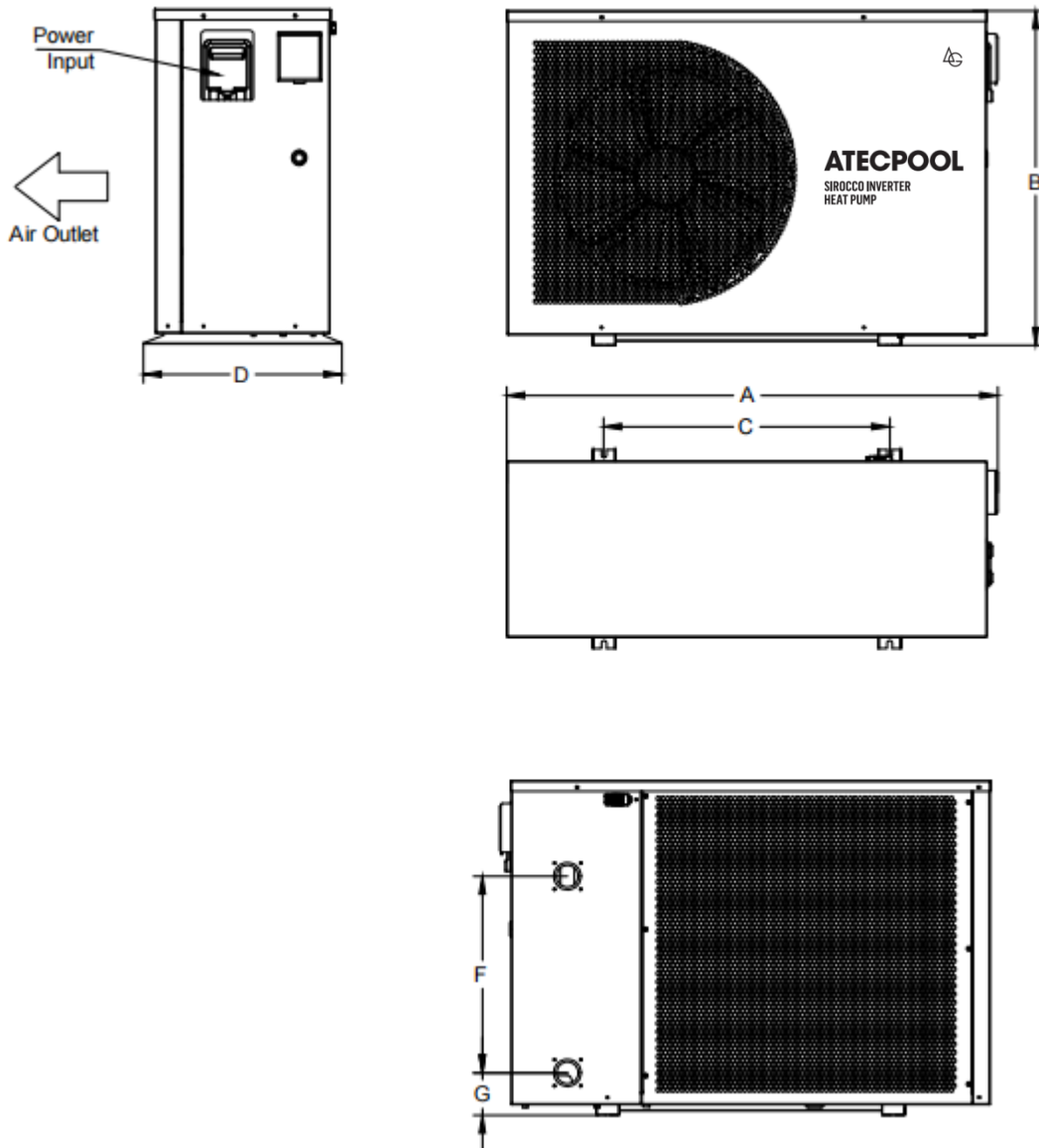

Model	A	B	C	D	F	G
AIHP115	980	660	666	399	380	97
AIHP180						
AIHP212	1125	765	655	455	450	97
AIHP253	1111				470	

3. Exploded View

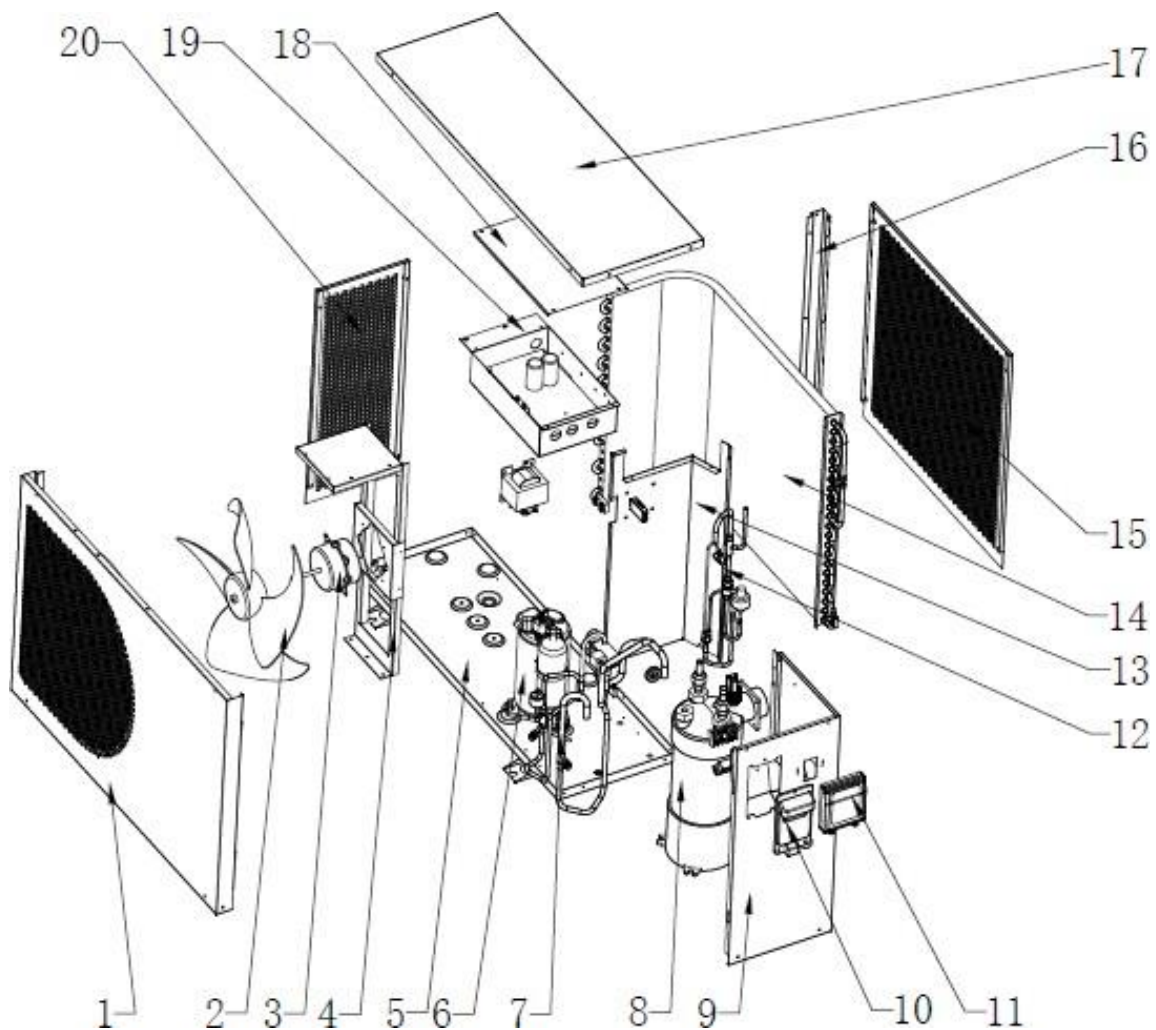

1	Front plate	9	Right plate	17	Top cover
2	Fan	10	Handle	18	Electrical box cover
3	Motor	11	controller / display	19	Electrical box
4	Motor support	12	EEV component	20	Left plate
5	Right plate	13	Middle plate		
6	Compressor	14	Evaporator		
7	Four way valve	15	Back plate		
8	Titanium heat exchanger	16	Pillar		

III. Installation Instructions

WARNING: Only a professional is allowed to install the heat pump. Unqualified users cannot install by themselves, otherwise the heat pump might be damaged and the user's safety will be risked. This section is provided for information purposes only and must be checked and adapted if necessary, according to actual installation conditions.

1. Pre-Requirements

Equipment needed for installation of heat pump:

- Suitable power supply cable for unit's power.
- A by-pass kit and an assembly of PVC tube, stripper, PVC adhesive and sandpaper.
- A set of wall plugs and an expansion screw.
- We recommend using a flexible PVC pipe in order to reduce transmission of vibration.
- Suitable fastening studs may be used to raise the unit.

2. Location and pipe connection

IMPORTANT: The inverter pool heat pump should be installed in a good ventilation place.

- 1) The frame must be fixed by bolts (M10) to a concrete base or brackets. The concrete base must be solid and fastened; the bracket must be strong enough and antirust treated;
- 2) Please don't stack substances that will block air flow near inlet or outlet area, make sure there is no barrier within 50cm behind the main machine, or the efficiency of the heater will be reduced or the machine may break;
- 3) The machine needs an appended pump (not included with the heat pump).
For the recommended pump specification-flux: refer to Technical Parameter,
Max. Lift $\geq 10\text{m}$;
- 4) When the machine is running, there will be condensation water discharged from the bottom, please pay attention to it. Please hold the drainage nozzle (accessory) into the hole and clip it well, and then connect a pipe to drain the condensation water out.

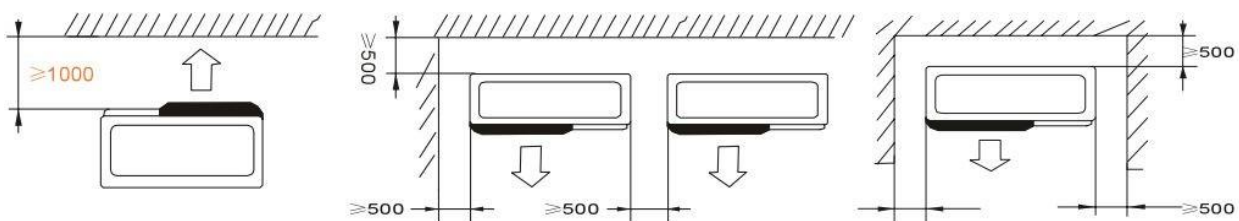

Do not place anything within at least 1m in front of the heat pump. Leave at least 50cm of empty space around the sides and rear of the heat pump. Do not put anything on or in front of the heat pump!

The inlet and outlet water unions can't stand the weight of soft pipes. The heat pump must be connected with hard pipes!

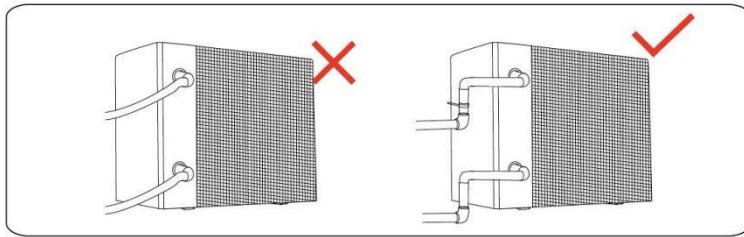

3. Installation Layout

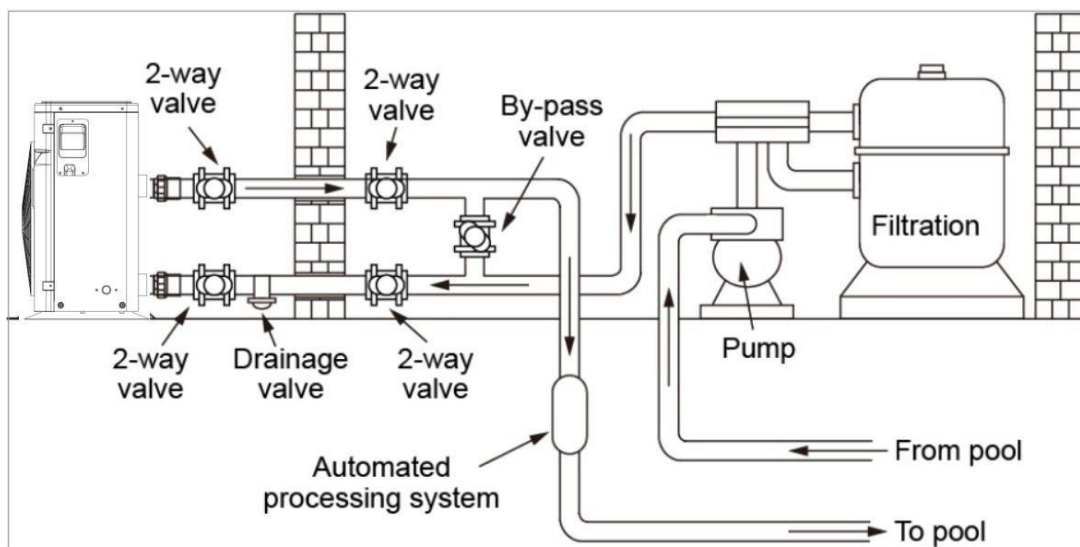

The heat pump is connected to a filtration circuit with a by-pass valve. The by-pass valve should be half-opened (throttled), while all the other valves should be completely opened. It is suggested that the by-pass valve only be opened half way to avoid excessive pressure on the heat pump.

It is imperative that the by-pass is placed after the water pump and filtration. The by-pass path usually consists of 3 valves. That makes it possible to adjust water flow which passes through the heat pump and isolates the heat pump completely from any maintenance without affecting flow of filtration cycle. The filter must be cleaned regularly to ensure that the water in the system is clean and avoids blocking the filter. It is necessary that the drainage valve is fixed on the lower water pipe. If the unit is not running during winter time, please disconnect the power supply and let water drain out from the unit through the drainage valve. If the ambient temperature of the running unit is below 0°C, please keep the water pump running.

4. Electrical Connection

Power Supply Wires Size

Model	Power Supply Wires		
	Electricity Supply	Cable Diameter	Specification
AIHP115	220-240V~/50Hz	3×2.5mm ²	AWG 14
AIHP180	220-240V~/50Hz	3×2.5mm ²	AWG 14
AIHP212	380-415V/3N~/50Hz	5×4.0mm ²	AWG 12
AIHP253	380-415V/3N~/50Hz	5×4.0mm ²	AWG 12

- ⚠ WARNING: Power supply of heat pump must be disconnected before any operation.**
- ➤ **Please comply with the following instruction to connect the heat pump.**
 - ➤ **Step 1: Detach electrical side panel by a screwdriver to access the electrical terminal block.**
 - ➤ **Step 2: Insert cable into heat pump unit port.**
 - ➤ **Step 3: Connect power supply cable to terminal block according to the diagram below.**

4.1 Wiring:

- a. Connect to appropriate power supply; the voltage should comply with the rated voltage of the products.
- b. Earth the machine well.
- c. Wiring must be handled by a professional technician according to the circuit diagram.
- d. Set leakage protector according to the local code for wiring (leakage operating current ≤ 30mA).
- e. The layout of power cable and signal cable should be orderly and not affecting each other.

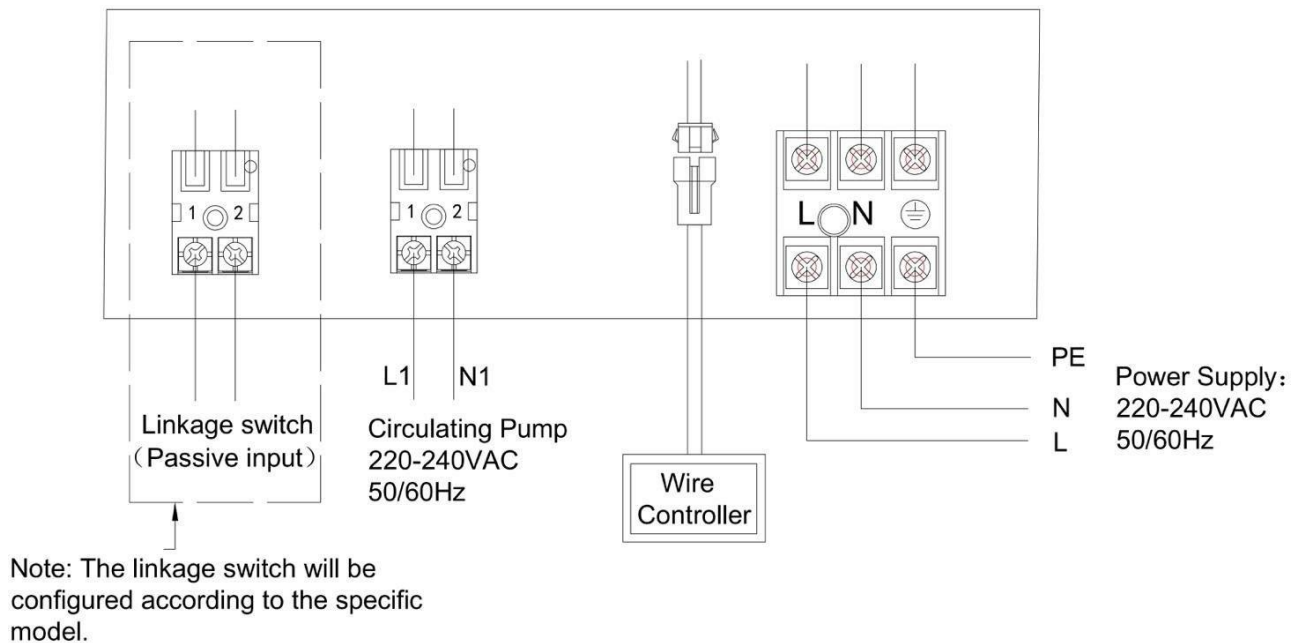

IV. Running Test

1. Inspection Before Running Test

a. Please run an inspection test after completing installation;

b. Before running test, confirm below items and write \checkmark in the block;

- Unit installed correctly
- Power supply voltage is the same as unit rated voltage
- Correct piping and wiring
- Air inlet and outlet ports from the air unit unblocked
- Drainage and venting are unblocked and no water leaking
- Leakage protector is working
- Piping insulation is working
- Ground wire is connected correctly

c. All wiring and piping should be connected well and carefully checked, then fill the water tank with water before power is switched on;

d. Empty all air within pipes and from water tank, then press “on-off” button on control panel to run the unit at setting temperature;

e. Items need to be checked during running test:

- During the first running, check if unit current is normal or not;
- Check if each function button on control panel are functioning correctly or not;
- Display screen is correct or not;
- Is there any leakage in the whole heating circulation system?
- Condensation drain is correct or not;
- Are there any abnormal sounds or vibration while running the unit?

2. Control Function Description















2.1 Operation Description

Controller Operation Description (Subject to specific model)











① Control Panel Diagram































② Panel Symbol Description

Symbol	Name	Symbol	Name	Symbol	Name
	On-off		Heating Mode or Defrosting		Silent Mode
	Set		Cooling Mode		Smart Mode
	Up		Key lock		Powerful Mode
	Down		Fault		Timer
	Mode		Wi-Fi		Wi-Fi

③ Operation Guideline List

NO.	Item	Operation Way
1	Unlock	Press the "  " and "  " keys for 3 seconds in the main interface to unlock /lock the screen.
2	On-off	In the main interface, press and hold the "  " key for 3 seconds to turn on / off.
3	Check Running Parameters	In the main interface, press and hold the "  " key for 3 seconds to enter the unit status parameter query, use the "  " and "  " keys for parameter browsing, and press the "  " key to exit the parameter query. (See table 1)
4	Choose Mode	In the power on state, long press "  " for 3 seconds to switch to working mode: heating mode and cooling mode.
5	Mode Switch	In the power on interface, press "  " to switch frequency mode: mute, smart and strong mode.
6	Adjust Temperature	In the power on interface, press "  " or "  " to adjust the current mode setting temperature.

7	Adjust Time	<p>Long press " " and " " for 3 seconds to enter the clock setting state. First, the hour unit flashes, indicating that the hour value of the current time can be adjusted through " " and " " keys. Press the " " key for plus one hour, press the " " key for minus one hour.</p> <p>If you hold down the " " key or " " key for a long time, the hours will be incremented or decremented automatically.</p> <p>After setting the hour value, press " " again; At this time, the minute bit flashes, indicating that the minute value of the current time can be adjusted through the " " and " " key. After setting the minute value, press " " again to finish.</p>
8	Adjust Timing	<p>Press " " for 3 seconds to enter the timing setting: Enter timing selection when the clock flashes "timing on 1", use " " and " " to set times; Click again " " to change to the clock, " " and " " can set minutes; Click again " " to change, Set "Timing Off 1": The clock flashes, showing "Hour" and press Key C and " "、" "。 Click again " " to change to clock minute, use " "、" " to set minutes and more time settings. Press " " to Exit and Enter; The main interface will show the number of scheduled time periods; Cancel timing setting: When the set power-on time and power-off time are the same, the timing setting of the current time period is canceled.</p>
9	Forced Defrosting	<p>Press the " " and " " keys to enter the forced defrost mode. When entering the defrost, the screen flashes " ".</p>



10	Celsius/Fahrenheit switch	When off, press "  "and"  " for 3 seconds in main interface to switch Celsius /Fahrenheit.
11	Turn on Electric Heater Manually	Long press "  " for 3 seconds in main interface to turn on/off the electric heater function.

Table 1

Code	Meanings	Display Range
A01	Water inlet temperature	-30~99°C
A02	Water outlet temperature	-30~99°C
A03	Ambient temperature	-30~99°C
A04	Exhaust temperature	0~125°C
A05	Air inlet temperature	-30~99°C
A06	Outer coil temperature	-30~99°C
A07	Inner coil temperature	-30~99°C
A08	Main EEV opening	
A09	EEV opening (EVI)	
A10	Compressor current	
A11	IPM temperature	
A12	DC bus voltage value	
A13	Actual speed of compressor	
A14	DC fan speed	

3. Fault Code and Solution

3.1. Fault Code Description

During the running process, the unit may run into error and a relevant fault code will be displayed. Please turn off the unit and turn it on unit again after 30 seconds. After the code is no longer displayed, the unit will work normally. If the fault code is displayed again, please contact our company for troubleshooting!

A. Protection & Failure code

Code	Protection Code Description	Fault solution
Er. 03	Water flow protection	Check water flow switch, change the switch if necessary
Er. 04	Winter anti-freezing	Water pump will run automatically for first grade antifreeze
Er. 05	High pressure Protection	Measure the pressure value when the heat pump is heating/cooling. If it's higher than 44.0 bar, it means heat pump has got high pressure protection: 1. Detect EEV step, low pressure and suction temp; 2. Detect the inlet/outlet water temp,; 3. Check for air in the refrigeration system; 4. Clean the water exchanger or water filter
Er. 09	Communication failure between Display and PCB	1.Check if the communication connection wire between the display and PCB is properly connected. Change or mend the wire if necessary. Check the PCB or display. If damaged, change the corresponding part .
Er. 10	Communication failure of frequency conversion module (alarm when communication between display and PCB is disconnected)	Change PCB.

Er. 12	High exhaust temp protection	1. Replace the compressor exhaust temperature sensor. 2. Reconnect or clean compressor exhaust temperature sensor and wrap it with insulation tape. 3. Replace the controller or PC Board.
Er. 15	Water inlet temperature failure	Check the connection, change the sensor if necessary.
Er. 16	External coil temperature failure	Check the connection, change the sensor if necessary.
Er. 18	Exhaust temperature failure	Check the connection, change the sensor if necessary.
Er. 19	DC fan motor failure	1. Check DC fan motor. Change it if damaged. Check output port of DC fan motor on PCB. Change the PCB if there is no output.
Er. 20	Abnormal protection of frequency conversion module	Solve it according to the subsidiary error codes in the following table.
Er. 21	Ambient temperature failure	Check the connection, change the sensor if necessary.
Er. 23	Low outlet water temp protection when cooling	Check the water flow and water system, fix/replace it if necessary.
Er. 27	Water outlet temperature failure	Check the connection, change the sensor if necessary.
Er. 28	Compressor transformer over current protection	1. Wait for about 3-5 minutes before restarting the unit 2. Change the driver board if the compressor transformer is broken
Er. 29	Suction temperature failure	Check the connection, change the sensor if necessary.
Er. 32	High outlet water temperature protection when heating	Check the water flow and water system, mend it if necessary.
Er. 33	Outdoor coil high temperature protection	Wait for the ambient temperature drops and restart the unit.
Er. 42	Internal coil temperature failure	

E20 failure will display the following error codes at the same time, switching every 3 seconds. Error codes 1-128 appear in priority. When error codes 1-128 don't appear, then it will show error codes 257-384. If two or more error codes appear at the same time, then display error codes accumulate. For example, if 16 and 32 occur at the same time, it will show 48.

Code	Parameters	Fault Description	Fault Solution
1	IPM over current	IPM module issues	Replace the inverter module
2	Abnormal press synchronization	Compressor failure	Replace the compressor
4	Reservation	--	--
8	Compressor output phase loss	Compressor connection broken, bad contact	Check compressor circuit
16	DC bus voltage is low	Input voltage is too low, pfc module fault	Check input voltage, replace module
32	DC bus voltage is high	Input voltage is too high, pfc module fault	Replace the inverter module
64	Imp temp. is too high	Fan failure, air duct blockage	Check fan and air duct
128	Imp temp. fault	Short circuit or open circuit fault of IPM sensor	Replace the inverter module
257	Communication failure	The inverter module has not received the command from the main controller	Check the communication line between main controller and inverter module
258	AC input phase loss	Input phase loss (available for three-phase module)	Check the input circuit
260	AC input over current	Input three-phase unbalance (available for three-phase module)	Check the three-phase voltage
264	AC input voltage is low	Input voltage is low	Check the input voltage
272	High pressure failure	Compressor high voltage failure (reservation)	
288	IPM temp. too high	Fan failure, air duct blockage	Check fan and air duct
320	The peak current of the compressor is too high	Compressor current is too large, the driver and the compressor do not match	Replace the inverter module
384	PFC module temp. is too high	PFC module temp. is too high	Check the PFC module
272	High pressure failure	Compressor high voltage failure (Reservation)	
288	IPM temp. is too high	Fan failure, air duct blockage	Check fan and air duct
320	The peak current of the compressor is too high	Compressor current is too high, the driver and the compressor do not match	Replace the inverter module
384	PFC module temp. is too high	PFC module temp. Is too high	Check the PFC module

3.2. Troubleshooting

Phenomenon	Cause	Solution
Unit is not running	<ol style="list-style-type: none"> 1. Power outage. 2. Power switch is not connected. 3. Power switch fuse is burned-out. 4. Timing is not up. 	<ol style="list-style-type: none"> 1. Please wait for power supply recovery. 2. Connect the power switch. 3. Replace the fuse. 4. Please wait or cancel the timing setting.
Unit is not running after starting up	<ol style="list-style-type: none"> 1. Compressor protection time interval has not ended. 2. Water temperature of the unit does not reach the water temperature needed to start up. 	<ol style="list-style-type: none"> 1. Please wait patiently for the end of protection time. 2. Wait for water temperature to reach the level needed.
Unit is running normally, but hot water temperature is low	<ol style="list-style-type: none"> 1. Improper temperature setting 2. Large hot water consumption 3. Air inlet port or outlet port of outdoor machine or indoor machine is blocked 	<ol style="list-style-type: none"> 1. Set up proper temperature 2. Wait for temperature of hot water to rise 3. Clear tuyere obstruction
Unit is running automatically	Reach timing to start up	Please shutdown manually or cancel timing if don't need start up

V. WIFI Settings

Press and hold the "-" and "  " keys at the same time for 3 seconds to enter the WI-FI

network. When entering, the "  " icon will flash fast for 3 seconds and then flash slowly;

- App Download Search "**Smart:Life**":

Start the software

After the installation is complete, tap the icon to start the software "Smart Life"

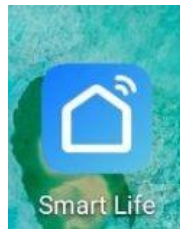

User registration

The first time you use "Smart Life "software, you need to register your user.

Click "Create a new user" link to enter the registration method interface

If you already have an account, click directly to sign in

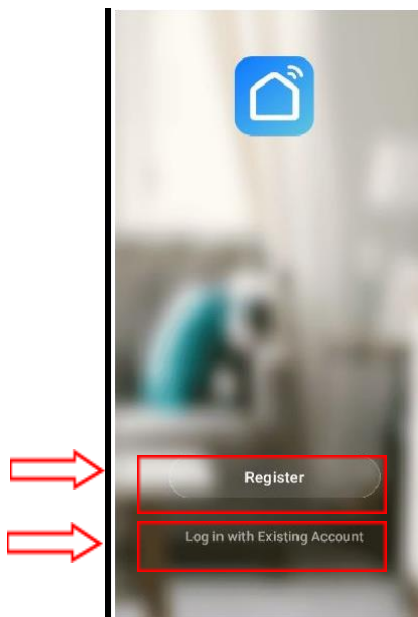

When an user enters the registration page, please follow the steps to register your user

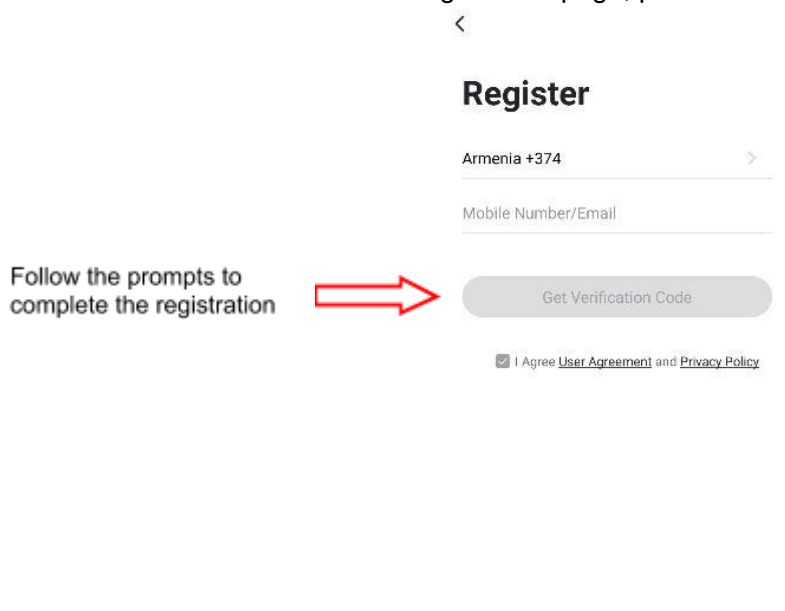

User Login:

Once the registration is successful, the software will jump to the login screen. Enter the correct "user name" and "password" to log in.

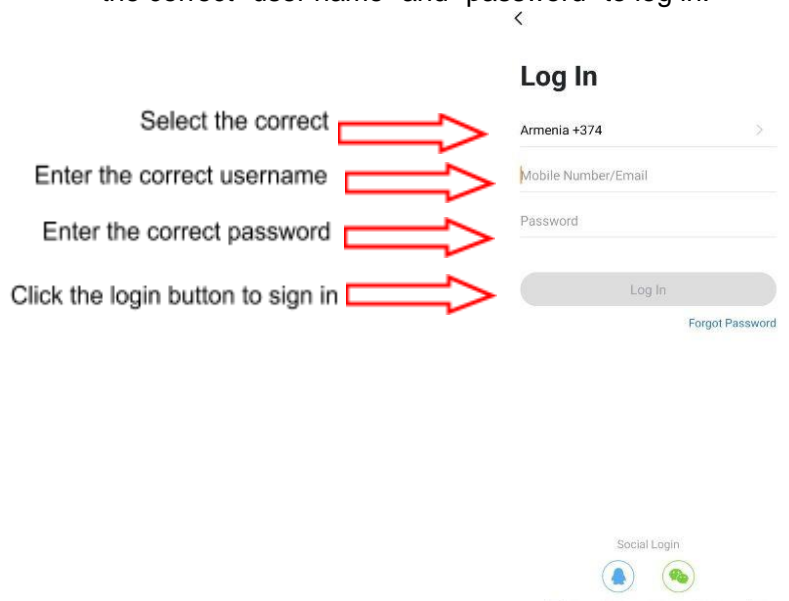

Mobile phone needs to be connected to the network via WIFI

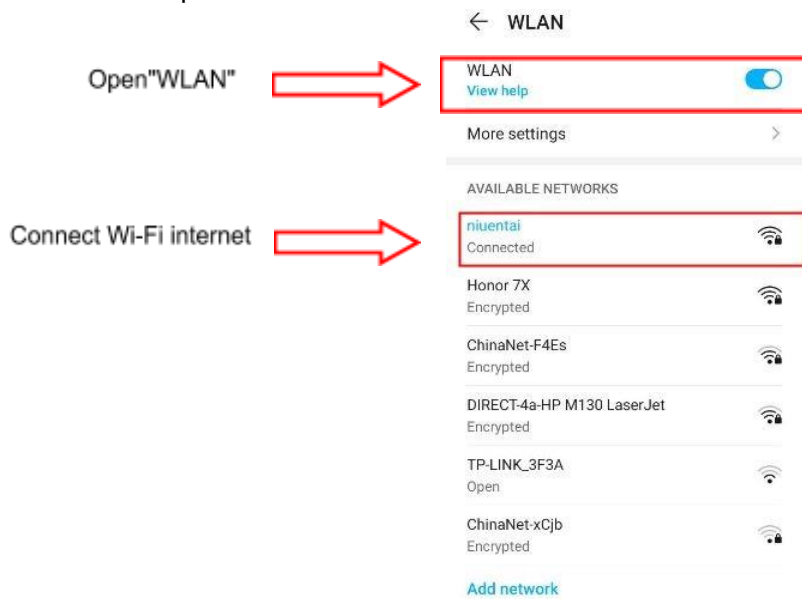

This WIFI is not the WIFI inside the module, it is a WIFI network that you can connect to the unit. After the user logs in to the APP, device connection is needed. Click on the top right corner to make a connection "+" or "Add a device"

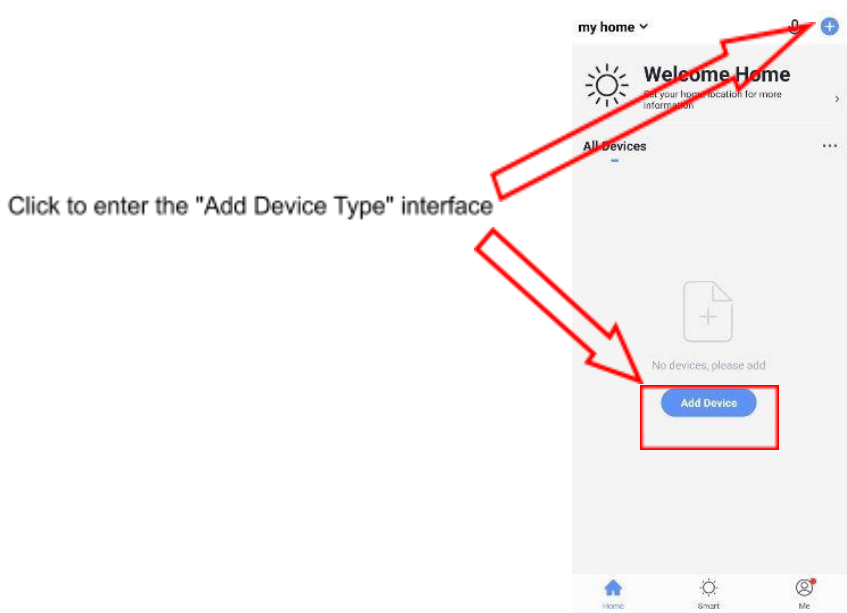

Go to the right interface

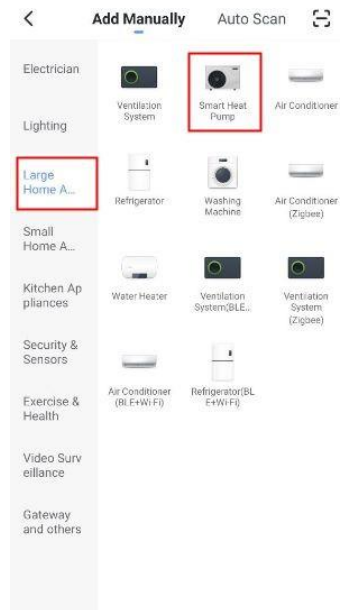

When device type selected, go to add "device interface".

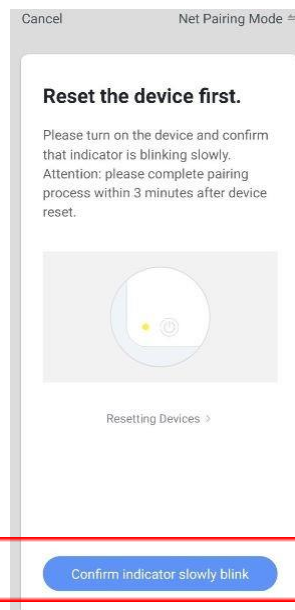

The wire controller holds down at the same time "-" and ""



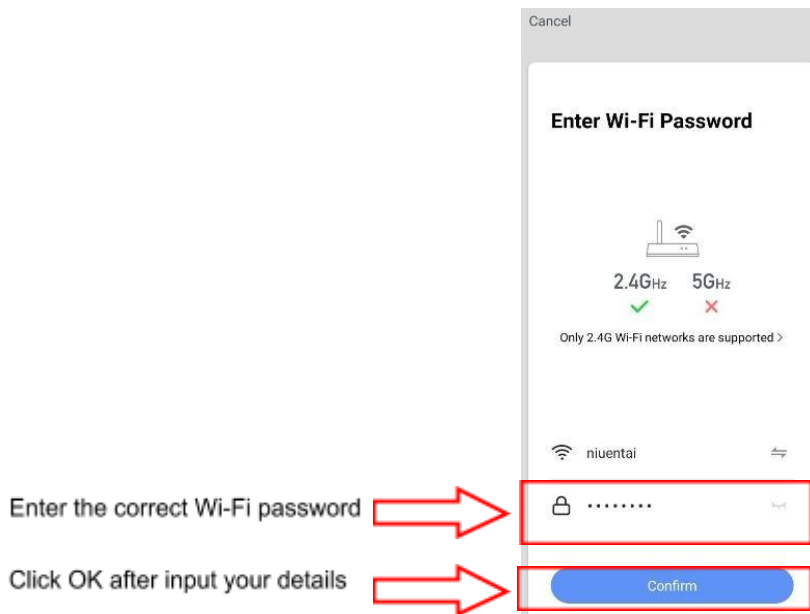

Click to connect to go to Wi-Fi interface, choose the wifi name :SmartLife-xxxx



Select, connect and return to the APP interface, entering the network process



Wait for the pairing process to end and then enter the distribution network process.

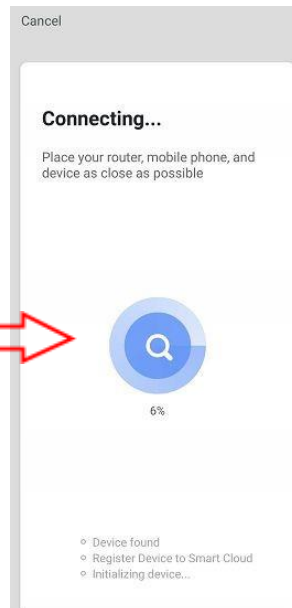
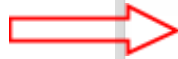

Unit successfully added, showing device connected. Click to enter control.

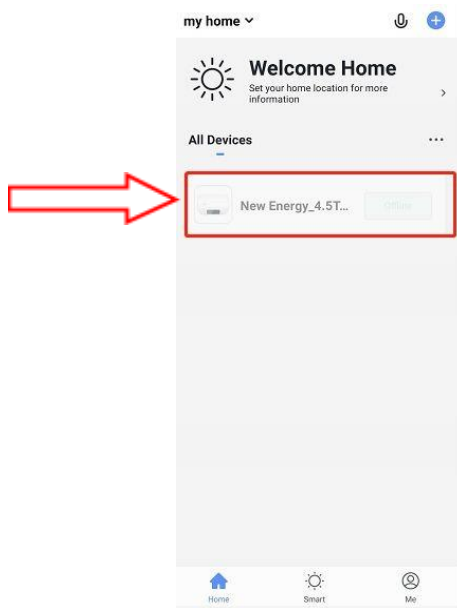

Set temperature selection, which can be set by sliding dot



Device operating mode selection



Switch control

Timing settings, you can set timing ON or OFF automatically

